



WGX





WGX





## WGX

A wardrobe that wants to attract attention. With its distinctive design language and selected colors, this wall-mounted coat rack makes every modern decor shine.

In any conceivable combination the colors can freely be attached to any wall.

In addition to its design, the focus was on the usage of sustainable materials and a production „Made in Germany“.

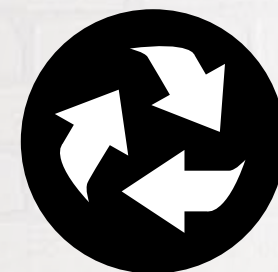

### 100% RECYCLED

This product is made from 100% recycled aluminum. Because this material retains its properties and can be reused after any number of cycles, we are talking about „real“ recycling.

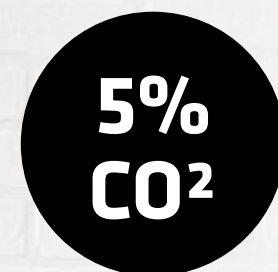

### REDUCED POWER CONSUMPTION

The energy used to recycle aluminum is up to 95% lower compared to the primary production ie only 5% of the energy.



### PRODUCED SUSTAINABLY

Our aluminum travels short distances - a key factor in reducing CO<sup>2</sup> emissions. Sustainable and local!

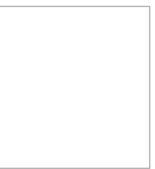



**Options**

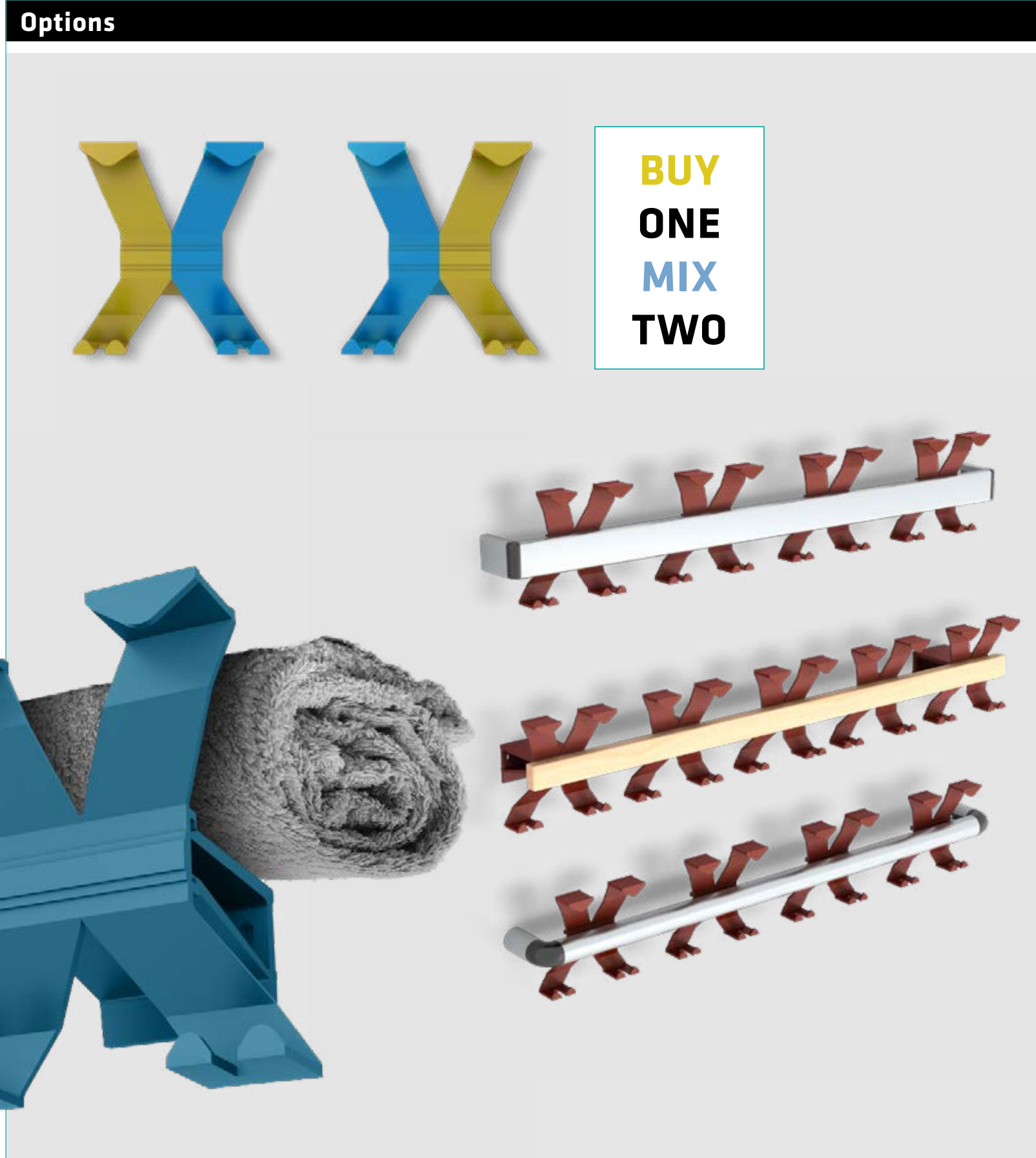





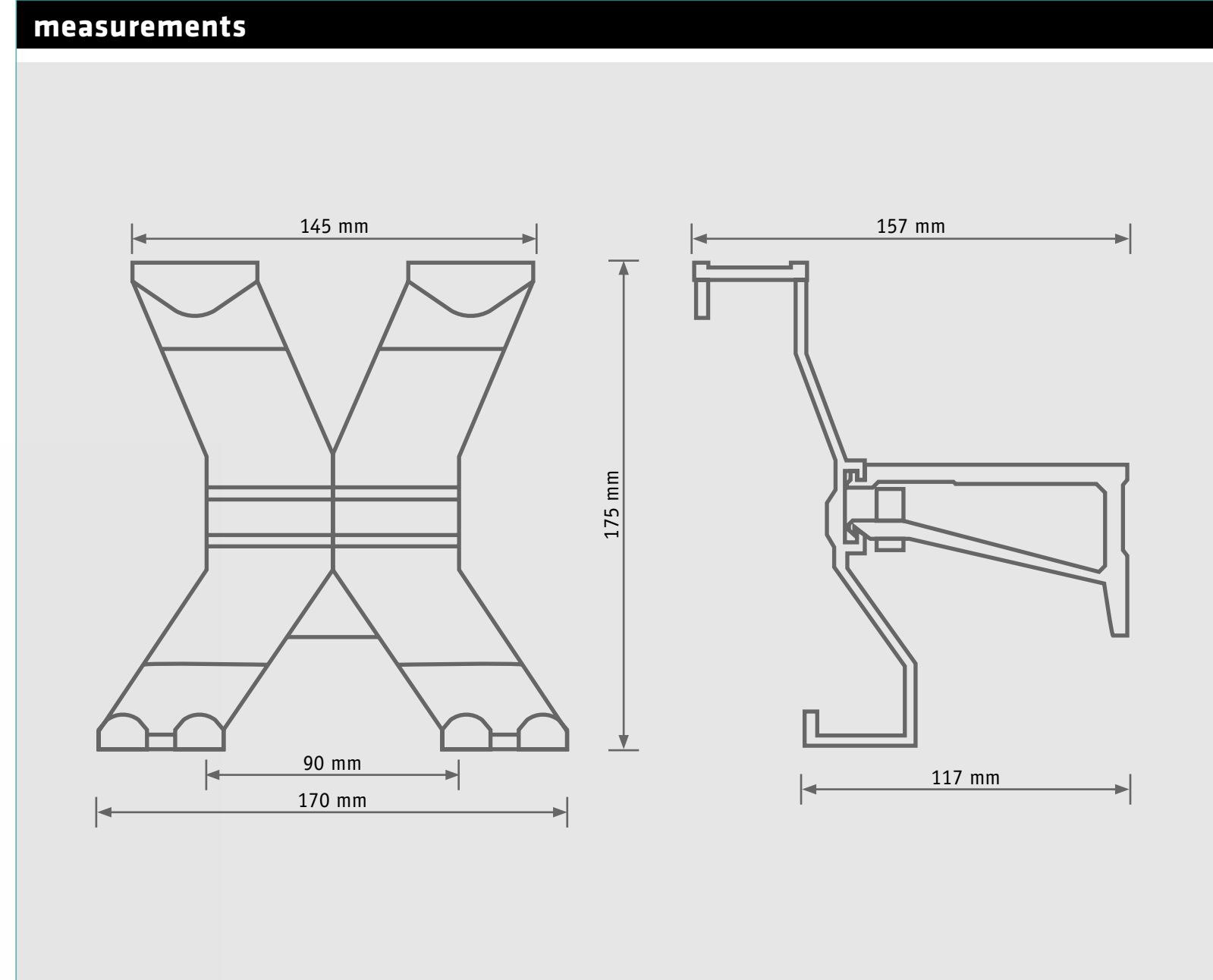

**BUY ONE MIX TWO**

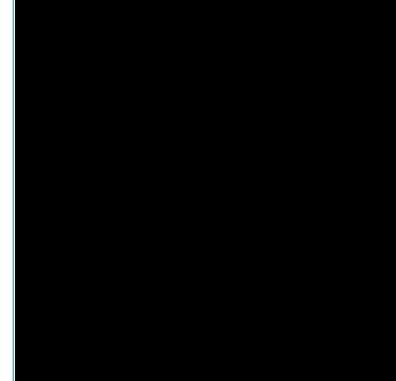
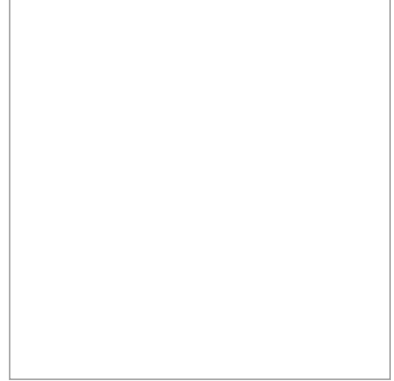
**measurements**

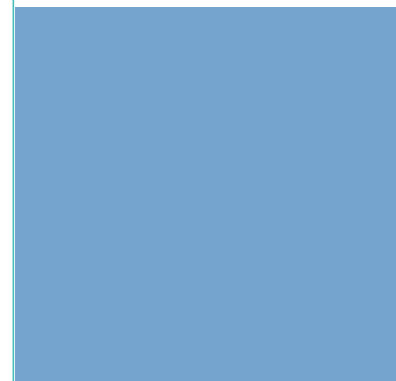

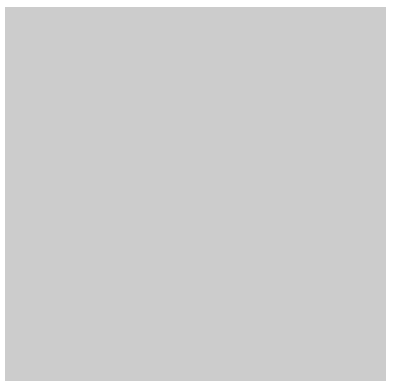
**A Colour**

<b>1</b> RAL9005	<b>2</b> RAL9003	<b>3</b> RAL1018	<b>4</b> RAL6027
			
<b>5</b> RAL5024	<b>6</b> RAL3018	<b>7</b>	<b>8</b>
			

Choose between the following color variants:

<b>1</b> black fine structure	<b>3</b> yellow fine structure	<b>5</b> blue fine structure	<b>7</b> natural anodized
<b>2</b> white fine structure	<b>4</b> green fine structure	<b>6</b> red fine structure	<b>8</b> black anodized
			<b>9</b> additional colors on demand

The combination possibilities of the coat hook **WGX** are manifold. As a single piece or in conjunction with other even differently colored hooks, this product can be customized according to your mood.

Another highlight is the possibility to combine the **WGX** with other wardrobes from our range. Get in touch with us!

Now configure your desired coat rack. The product base number together with your selection create the article number. Using this number you can order from us by phone or by email:

Tel. +49-2334 9096-10  
 info@garderoben-haarmann.de

Base number **A**

**WGX**

For more information on ordering and your article number please see page 2!

Technical details as at 06/2019, subject to modification

**SAMPLE ARTICLE NUMBER**

**Configure your desired coat rack**

**Order**

1.

Assemble your desired coat rack using the fact-sheet. This will then be individually manufactured according to your requirements - Quality directly from the manufacturer!

3.

Order using your article number by phone or by email:

**Tel.+49-2334 9096-10**  
**info@garderoben-haarmann.de**

**The correct article number**

2.

Select from the respective options in the categories A-F. The result is the article number, which you use to order directly from us.

**If you still have questions, then simply call us or send us an e-mail.**



**How can I get my correct article number?**

Easy. For example you want to configure and order the coat rack stand 70\*28?

Proceed as follows: First of all select the desired profile from category **A** e.g. option 2 - the right corner profile 65\*22mm. The first digit after the base number **RG70\*28** is 2.

Select the respective options from the remaining categories. The last 3 or 4 digits are taken from the length of the coat rack, category **F**. For example If you select for a 660 mm long coat rack, the last 3 digits of the article number will be 660.

